

Article number: 20278B50MZ2SW

Description: E+G Swivel clamp connector
GN278-B50-MZ-2-SW

Measures

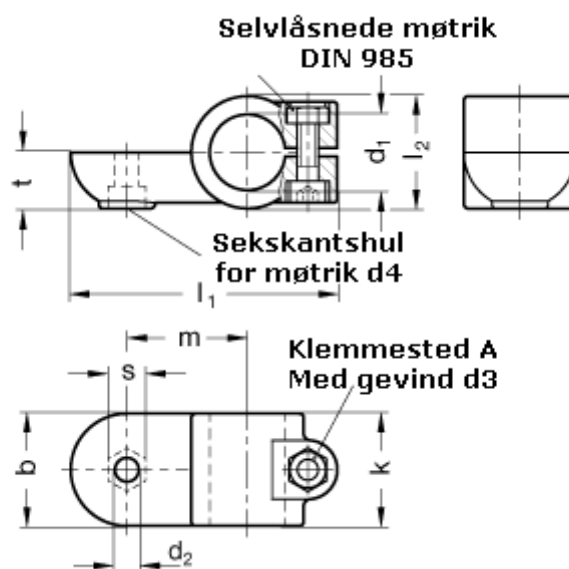

$b = 65$	$m = 70$
$d_1 = B50$	$s = 17.0$
$d_2 = 10.5$	$t = 32.5$
$d_3 = M10$	
$d_4 = M10$	
$k = 65$	
$l_1 = 148$	
$l_2 = 65$	